



RMT-173-3G Series

- RMT-173-3G-TT
- RMT-173-3G-RM

17.3" Audio/Video Tabletop and Rack Monitors User Guide

User Guide

Part Number 821100, Revision B

© 2016 Wohler Technologies, Inc. All rights reserved.

This publication is protected by federal copyright law. No part of this publication may be copied or distributed, stored in a retrieval system, or translated into any human or computer language in any form or by any means electronic, mechanical, manual, magnetic, or otherwise, or disclosed to third parties without the express written permission of Wohler Technologies.

Reproduction

Licensed users and authorized distributors of Wohler Technologies, Inc. products may copy this document for use with Wohler Technologies., Inc. products provided that the copyright notice above is included in all reproductions.

Customer Support

Wohler Technologies, Inc.
31055 Huntwood Avenue
Hayward, CA 94544 www.wohler.com
Phone: 510-870-0810
FAX: 510-870-0811
US Toll Free: 1-888-596-4537 (1-888-5-WOHLER)
Web: www.wohler.com Sales: sales@wohler.com
Support: support@wohler.com

Disclaimers

Even though Wohler Technologies, Inc. has tested its equipment and software, and reviewed the documentation, Wohler Technologies, Inc. makes no warranty or representation, either express or implied, with respect to software, documentation, their quality, performance, merchantability, or fitness for a particular purpose.

In no event will Wohler Technologies, Inc. be liable for direct, indirect, special, incidental, or consequential damages resulting from any defect in the hardware, software, or its documentation, even if advised of the possibility of such damages.

Some states do not allow the exclusion or limitation for incidental or consequential damages, so the above exclusion or limitation may not apply to you.

Printing

This document looks best when printed on a color printer since some images may be indistinct when printed on a black and white printer.

PDF

All text strings underlined in [this shade of blue](#) are hyperlinks within this document.

Other Technologies and Products

Google Chrome is a registered trademark of Alphabet Inc. Microsoft Windows and Internet Explorer are registered trademarks of Microsoft Corporation. Evertz and MAGNUM are registered trademarks of Evertz Microsystems Ltd.

Last Update

December 13, 2016

TABLE OF CONTENTS

Contents

User Guide	1
TABLE OF CONTENTS	3
Contents	3
CHAPTER 1: Installation	5
Introduction	5
Overview.....	5
Features	5
Safety.....	5
Instructions.....	5
Safety Symbols.....	6
Mounting.....	6
Heat Dissipation.....	7
Sympathetic Vibration.....	7
Mechanical	7
Electrical Interference.....	7
Power	7
Compliance	8
FCC	8
ICES-003	8
CHAPTER 2: Local Operation	9
Front Panel	9
On-Screen Display Features.....	10
Rear Panel.....	12
Rear Panel Connectors	15
Using the Quick Menu and the OSD Menus	16
Quick Menu	16
OSD Menus	16
OSD Menus	17
CHAPTER 3: Technical Info	29
Supported Video Formats	31
CHAPTER 4: Using Network Control	32
Web Browser / Control Device	32
First Time- IP Assignments	32
Status Page.....	33
Adjust Page.....	35
Video Display Page.....	35
Input Setup Page	36

Marker Page	37
Audio Page	38
Display Page.....	39
Close Caption Page.....	39
Config Page	40
Color Temperature Page.....	41
Function Key Page.....	41
IMD Page	42
GPI Page	43
System Page	44

CHAPTER 1: Installation

Introduction

Overview

The RMT-173-3G Series monitors set a new standard in LCD monitors for broadcast and professional video applications. The RMT-173-3G-TT is a tabletop monitor and the RMT-173-3G-RM is a rack mount monitor. Both provide a 17.3", 8-bit, 1920 x 1080 resolution, 16:9 format, anti-glare IPS LCD screen. All video formats are scaled to fit on the screen in the highest quality using 10-bit digital processing, precision scaling and gamma correction to produce the best images possible.

Features

The RMT-173-3G Series audio/video monitors are designed for confidence monitoring of two 3G/HD/SD-SDI, one HDMI/DVI, one CVBS composite analog video, and one Y/C and component input. Input signals are easily selected and displayed. Two to sixteen audio channels may be selected for visual monitoring on bar graph style level meters. On screen markers, waveform, vector, Picture in Picture (PiP) and Picture by Picture (PbP) displays can be enabled on this full-featured monitor. Focus Assist and Luma Zone modes can be engaged to assist with camera adjustments. Stereo speakers provide audio monitoring. A headphone jack and stereo analog audio outputs are also provided for external audio monitoring.

Parameters are selected and adjusted using an On Screen Display (OSD) Menu. An RJ45 connector serves as the interface to six general purpose inputs which can be optioned to control a variety of monitor functions. Monitor settings can also be made with a web browser over Ethernet using the integral web server.

Safety

Instructions

1. Read, keep, and follow all of these instructions; heed all warnings.
2. Do not use this equipment near water.
3. Use only a dry cloth to clean the equipment.
4. Do not block any ventilation openings.
5. Do not install near any heat source such as a radiator, heat register, amplifier, or stove.
6. Do not attempt to plug the unit into a two-blade outlet (with only two prongs of equal width).

Important:

By design, this monitor will only plug into a three-prong outlet for your safety. If the plug does not fit into the outlet, contact an electrician to replace the obsolete outlet.

7. Protect the power cord from being walked on or pinched, particularly at plug connection on the equipment and at the socket.
8. Use only the attachments/accessories specified by the manufacturer.
9. Unplug the equipment during lightning storms or when unused for long periods of time.
10. Refer all servicing to qualified service personnel. Servicing will be required under all of the following conditions:
 - a. The equipment has been damaged in any way, such as when the power-supply cord or plug is damaged.
 - b. Liquid had been spilled or objects have fallen onto the equipment.
 - c. The equipment has been exposed to rain or moisture.
 - d. The equipment does not operate normally.
 - e. The equipment has been dropped.

Safety Symbols



The symbol to the left warns of electric shock hazard inside the unit. Disconnect the power cord before removing access panels when installing upgrades. Only qualified service personnel are to operate the equipment with covers removed, and are to exercise caution to avoid personal injury.

Mounting

The RMT-173-3G-TT is designed to be placed on a tabletop or other flat surface. The RMT-173-3G-RM is designed to be mounted in 6RU of a standard 19" rack. It may be tilted forward for easier viewing. Position either unit at ear/eye level for best high frequency response and visual observation of the display screen. Please adhere to the following clearances:

Table 1-1: Recommended Clearances

Clearance	Surface
24"	Front
3"	Rear
2"	Sides
1.75"	Top and Bottom (if near other equipment)
0"	Top and Bottom (if no other equipment)

Heat Dissipation

The ambient temperature near the product should not exceed 40° Celsius (104° Fahrenheit). When rack mounting, adjacent devices can be rack mounted in proximity to the unit if this temperature is not exceeded. Otherwise, allow a 1RU (1.75"/44.45mm) space above and below the unit for air circulation. For table top operation, in warm environments, allow an inch of space above and below the unit for air circulation.

Important

To reduce noise, the monitor does not have any fans. As a result, the heat generated by the audio amplifiers, power supplies, and other components is vented by slots in the back of the unit. Therefore, as a safety precaution, you must allow proper ventilation on these surfaces.

Sympathetic Vibration

Sympathetic vibration from other equipment (cables, etc.) in the rack may be serious enough to interfere with the unit's sound quality. If you experience sympathetic vibrations, use thin card stock, felt, foam, or weather-stripping between the vibrating surfaces. Tie loose cables securely with cable ties.

Mechanical

The rack chassis is securely attached its mounting brackets. In addition, the chassis is very shallow from front to back. This feature will reduce or eliminate rear bracing requirements in many mobile/portable applications. It can be tilted downward for viewing, if necessary. The weight of internal components is distributed fairly evenly around the unit.

Electrical Interference

Be careful to avoid mismatched cable types and other similar causes of undesired reflections in digital signal systems. If severe enough, such reflections can result in corruption of the digital data stream. As with any audio equipment, maximum immunity from electrical interference requires the use of shielded cable; however, satisfactory results can sometimes be obtained without it. The internal circuitry ground is connected to the chassis.

Power

The unit comes with an external power supply module which connects to an AC mains power source (60W, 100 to 240 VAC, $\pm 10\%$, 50/60Hz) through the IEC connector provided on the power supply.

When the mains plug or appliance coupler is used as the disconnect device, the disconnect device should remain operable.

Compliance

FCC

This equipment has been tested and found to comply with the limits for a Class A digital device, pursuant to part 15 of the FCC Rules. These limits are designed to provide reasonable protection against harmful interference when the equipment is operated in a commercial environment. This equipment generates, uses, and can radiate radio frequency energy and, if not installed and used in accordance with the instruction manual, may cause harmful interference to radio communications. Operation of this equipment in a residential area is likely to cause harmful interference, in which case the user will be required to correct the interference at their own expense.

ICES-003

This Class A digital apparatus complies with Canadian ICES-003.

Cet appareil numérique de la classe A est conforme à la norme NMB-003 du Canada.

CHAPTER 2: Local Operation

The RMT-173-3G Series front and rear panels are described in this chapter.

Front Panel

The RMT-173-3G-TT table top and RMT-173-3G-RM rack mount front panels are identical. Figure 2-1 shows the RMT-173-3G-TT with its table stand.

Figure 2-1: Front Panel Layout

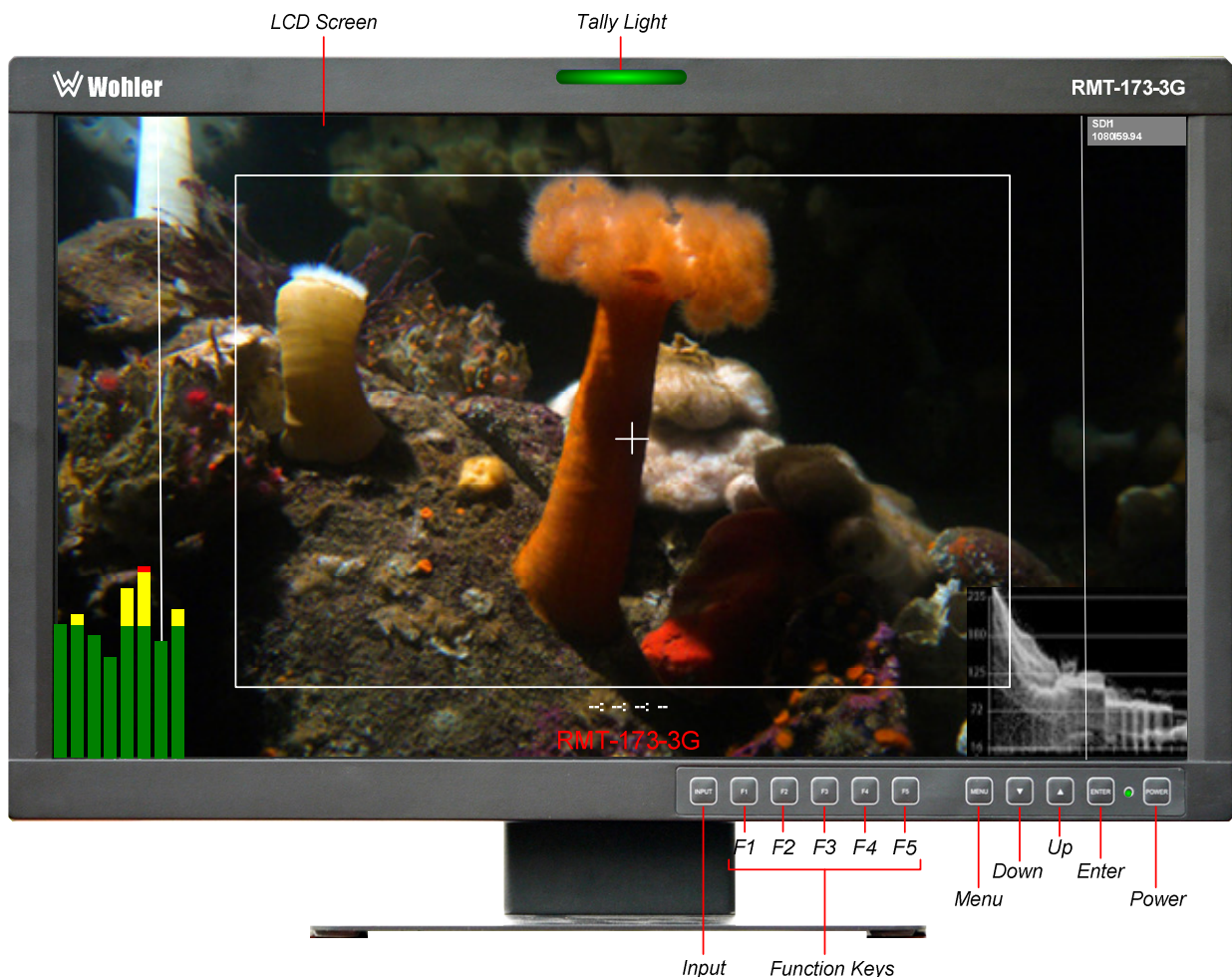

1. **Tally Lights:** This tri-color (red/green/amber) light is controlled through a RJ45 connector or through the GPI connector on the rear panel. For more information about the RJ45 connector, refer to the Rear Panel section of this chapter. When first connected to power, the Tally Light glows amber until the unit is ready for operation.
2. **LCD Screen:** The LCD screen displays the audio meters, Picture in Picture (PiP) and Picture by Picture (PbP) screens, closed captioning, waveform/vector, menus, and OSD features over the video.
3. **Power:** The **Power** button turns the LCD screen to On or Standby mode. The

adjacent **Power Indicator** glows green to indicate On and red to indicate Standby.

4. **Input:** The **Input** button selects the video/audio input to be monitored from the various connectors on the rear panel. The currently selected input source is indicated when the **Input** button is pressed. Repeated presses change the input source.
5. **Function Keys:** Press **F1**, **F2**, **F3**, **F4**, or **F5** to activate the assigned function. The default assignments are as listed in Table 2-1. The action of each **Function Key** can be selected from a wide variety of actions in the Function Key Menu as described in Table 2-14.

Table 2-1: Default Function Key Actions

Key	Default Action
F1	Scan
F2	Native
F3	Aspect Win Select
F4	Win Select
F5	PBP

6. **Menu:** Press this button to display the OSD Menu. Refer to the **OSD Menus** section of this chapter for operation and content of these menus.
7. **Enter:** When the OSD Menu is displayed, pressing this button accepts selections in the menus and sub-menus. When the OSD Menu is not being displayed, pressing this button displays the Quick Menu, which cycles through frequently used volume and image controls. Refer to the **Quick Menu** section of this chapter.
8. **Down:** When the OSD Menu is displayed, the **Down** button navigates down through the menu and sub-menu selections and can be used to adjust the settings. It also adjusts the items in the Quick Menu.
9. **Up:** When the OSD Menu is displayed, the **Up** button navigates down through the menu and sub-menu selections and can be used to adjust the settings. It also adjusts the items in the Quick Menu.

On-Screen Display Features

Functions and parameters can be selected and adjusted using the On Screen Display (OSD) Menu. Refer to the **OSD Menus** section of this chapter.

Overlays can be added by the operator for **Area & Safety Markers**, **Center Marker**, and to display names as **IMD (In Monitor Display)** for identification.

Video effects such as **Monochrome**, **Blue Only**, **Focus Assist**, **H/V Delay** and other features can be used to assist setup. For convenience and quicker access, these and other features can be assigned to the **Function Keys**.

Overscan, **Underscan** and **Native** modes control scaling and size of the video.

Audio level meter displays, for up to sixteen channels, can be displayed vertically or horizontally, positioned at various corners of the display. They can show VU, PPM (PK) or both with assignable -20db to -18db reference levels.

Waveform (Y or Line) and/or **Vectorscope** can be shown on the left or right bottom of the screen.

Closed Captions from CVBS Line 21 (CEA-608) can be decoded and text is displayed across the screen bottom. The 'CC' logo at screen top center indicates captions are present in the SDI stream.

The de-embedded **Timecode** from the HD/SD-SDI source displays on the lower part of the screen. Choose LTC, VITC or D-VITC types in the Display Menu.

Figure 2-2: Display Features

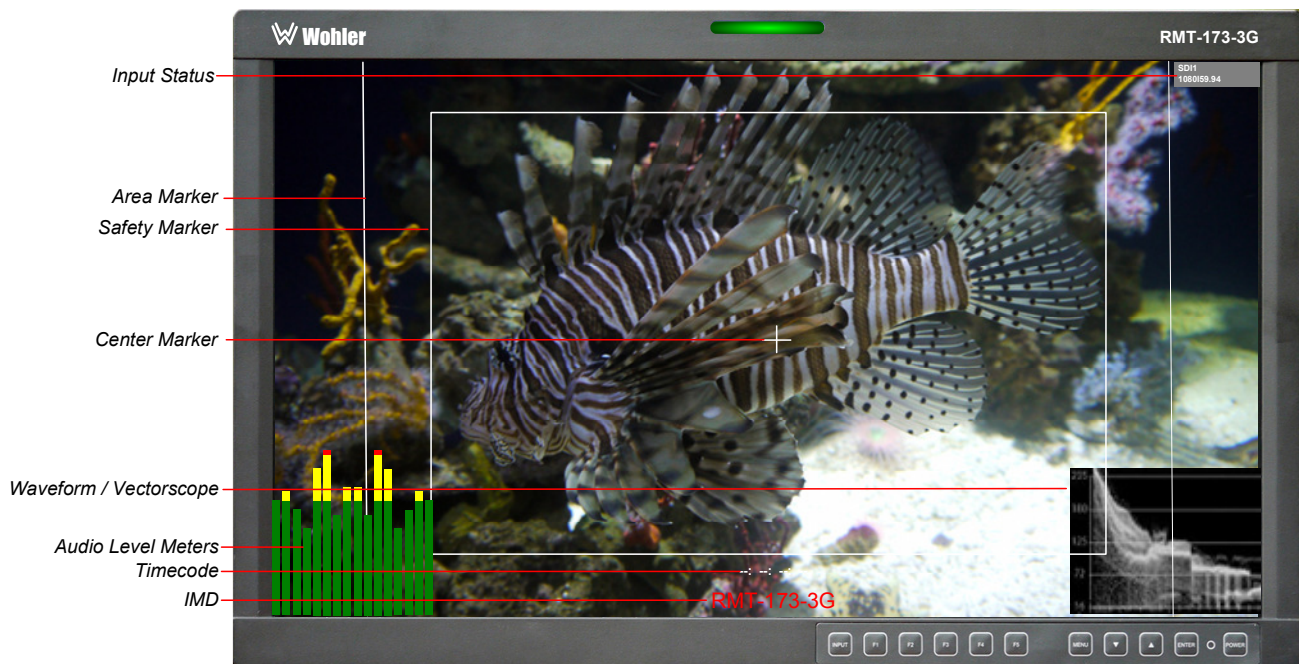

1. **Input Status:** Displays the detected input and video parameters of the signal: vertical active line count, (i)nterlaced or (p)rogressive, and field/frame rate in Hz. This display is controlled by a setting in the Display Menu. Refer to Table 2-9.
2. **Area Marker:** Used to mark an alternate aspect ratio area of the image. You can set whether to display it, the brightness, and the matte mode in the Marker Menu. Refer to Table 2-7.
3. **Safety Marker:** This is used to mark a percentage area, inside of the image, safe for titles to be located. You can set whether to display it, as well as its display mode, in the Marker Menu. Refer to Table 2-7.
4. **Center marker:** Cross hairs are displayed in the center of the screen, marking the center of the image. You can set whether to display them in the Marker Menu. Refer to Table 2-7.
5. **IMD:** The IMD Menu provides settings to customize the IMD (In Monitor Display) text area to show a static line of characters, numbers, and certain symbols or to receive dynamic messages to be displayed. Refer to Table 2-16.
6. **Audio Level Meters:** Levels for the audio channels are displayed on up to

- sixteen bar graph meters as left/right pairs. The meters can appear in various selectable positions on the screen. Refer to Table 2-8.
7. **Timecode:** The de-embedded timecode from the HD/SD-SDI source displays on the lower part of the screen. The timecode setting is located in the Display Menu. Refer to Table 2-9.
 8. **Waveform/Vectorscope:** This can be displayed only for SDI signals. The waveform and vector of the input signal display are configurable in the Display Menu. Refer to Table 2-9.

Rear Panel

Figure 2-3: RMT-173-3G Series Rear Panel Layout

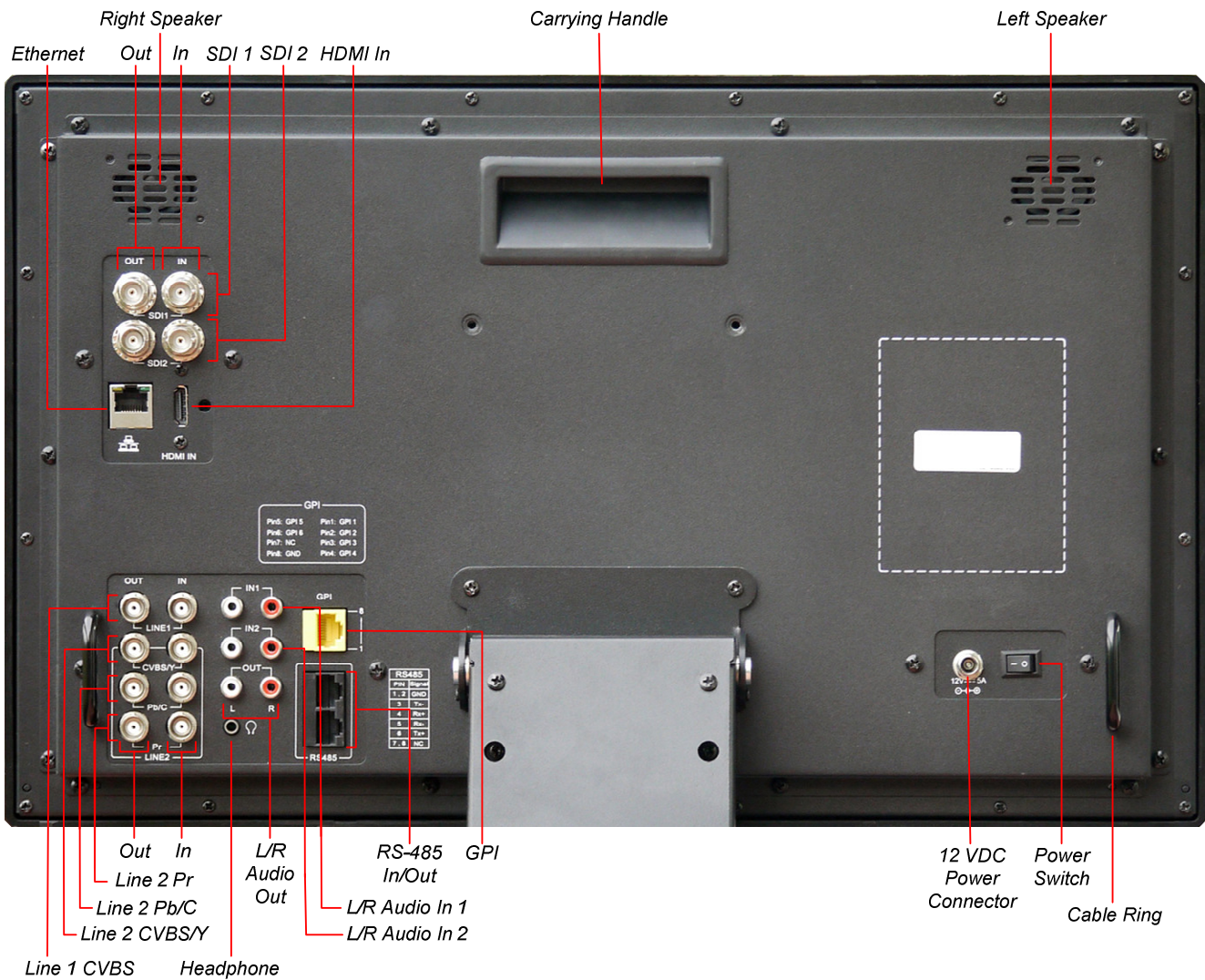

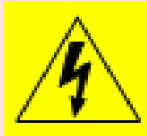
Important:

By design, the supplied AC mains power cord will only plug into a three-prong grounded outlet for your safety. If the plug does not fit into the outlet, contact an electrician to replace the obsolete outlet. The symbol to the left warns of electric shock hazard inside or outside the unit. Disconnect the power cord before removing access panels.

Important:

The monitor and power adapter have been tested as a combined apparatus to verify compliance with applicable safety and electromagnetic compliance standards. Use of another power adapter provided by the user may negate the compliance or not perform properly. Wohler Technologies cannot accept any responsibility for the outcome in such cases.

1. **SDI 1 In:** This input connector accepts 3G/HD/SD-SDI video signals. It is compliant with SMPTE 424M, SMPTE 259M, SMPTE292M/ITU-R BT601. It can be viewed using the SDI1 selection on the **Input** button menu.
2. **SDI 1 Out:** This connector provides a re-shaped and re-clocked duplicate of the **SDI 1 In** signal. This connection is compliant with SMPTE 424M, SMPTE 259M, SMPTE292M/ITU-R BT601.
3. **SDI 2 In:** This is the second 3G/HD/SD-SDI video signal input. This connection is compliant with SMPTE 424M, SMPTE 259M, SMPTE292M/ITU-R BT601. It can be viewed using the SDI2 selection on the **Input** button menu.
4. **SDI 2 Out:** This connector provides a re-shaped and re-clocked duplicate of the **SDI 2 In** signal. This connection is compliant with SMPTE 424M, SMPTE 259M, SMPTE292M/ITU-R BT601.
5. **Line 1 In Video:** This is the first input for an analog CVBS video signal. It can be viewed using the **LINE 1** selection on the **Input** button menu.
6. **Line 1 Out Video:** This is a pass through connection for the **Line 1 In** video signal.
7. **Line 2 In CVBS/Y:** This is the second analog CVBS video input signal or the luminance (Y) signal of Y/C or YPbPr. This input combined with the other Line In 2 input signals can be viewed using the **LINE 2** selection on the **Input** button menu.
8. **Line 2 Out CVBS/Y:** This is a pass through connection for the **Line 2 In CVBS/Y** video signal.
9. **Line 2 In Pb/C:** This is the chroma (C) signal of Y/C or YPbPr. This input combined with the other **Line In 2** input signals can be viewed using the **LINE 2** selection on the **Input** button menu.
10. **Line 2 Out Pb/C:** This is a pass through connection for the **Line 2 In Pb/C** video signal.
11. **Line In 2 Pr:** This is red (Pr) component of YPbPr. This input combined with the other Line In 2 input signals can be viewed using the **LINE 2** selection on the **Input** button menu.
12. **Line 2 Out Pr:** This is a pass through connection for the **Line 2 In Pr** video

- signal.
13. **HDMI In:** This input supports HDMI and DVI signals. It uses an HDMI Type-A connector. It can be viewed using the **HDMI** selection on the **Input** button menu.
 14. **Audio In 1:** A pair of analog audio inputs related to the Line 1 video signal is provided on RCA jacks. They have a 47K Ω input impedance and will accept up to a 5dBu signal. These inputs are selected when the **LINE 1** selection button is pressed.
 15. **Audio In 2:** A pair of analog audio inputs related to the Line 2 video signal is provided on RCA jacks. They have a 47K Ω input impedance and will accept up to a 5dBu signal. These inputs are selected when the **LINE 2** selection button is pressed.
 16. **Headphones:** A standard 1/8" stereo headphone jack is provided. The speakers will mute when a headphone is inserted into this jack.
 17. **Audio Out:** A pair of analog outputs is provided on RCA jacks. They will output the audio from the selected video source to be used with external amplifiers and speakers if needed. They have a 500 Ω output impedance and will produce up to a 5dBu signal.
 18. **Power Connector:** The supplied 100 to 240VAC to 12VDC power supply plugs into this coax connector.
 19. **Power Switch:** This switch removes all power from the product. Normally, since this switch is on the rear panel, it is left in the **1 (On)** position and the front panel **Power** button is used to start and stop product operation.
 20. **Ethernet:** The 10/100M Ethernet connector is used to connect with a computer to modify the display settings remotely. CAT5 network cables are recommended for medium distances. CAT6 twisted pair shielded cables are recommended for longer distances.
 21. **GPI:** This RJ45 jack controls the tally lights on the front panel. Refer to Figure 2-5 below for the pinout and Table 2-2 for the terminal connections. Either CAT5 or CAT6 cables may be used for this jack. The possible functions for GPI contact closures are described in the GPI Menu shown in Table 2-15.
 22. **RS-485 In/Out:** These RJ-45 jacks are used for dynamic Tally/IMD controls. Two jacks are provided for in & out daisy chain arrangements. They are wired identically. Refer to Figure 2-4 below for the pinout and to Table 2-3 for terminal connections. These connections are also used for system software upgrades. Either CAT5 or CAT6 cables may be used for these jacks.
 23. **Right and Left Speakers:** The audio monitoring speakers are positioned on the rear panel. The volume of the speakers is controlled using the Quick Menu. Refer to the Quick Menu section of this chapter.
 24. **Carrying Handle:** A carrying handle is provided so that the monitor can be securely carried from location to location.
 25. **Cable Rings:** Rings are provided on the right and left of the rear panel to be used for securing the connecting cables, if desired.

Rear Panel Connectors

The following figure and tables detail the connections of the General Purpose Inputs (GPI) and RS-485 connectors on the rear panel. The tables are also silkscreened on the rear panel of the unit for your convenience.

Table 2-2: GPI Input Connections

Pin	GPI Terminal Name
1	GPI 1
2	GPI 2
3	GPI 3
4	GPI 4
5	GPI 5
6	GPI 6
7	NC
8	GND

To activate a GPI, connect its associated pin (1-6) to ground (8).

Figure 2-4: GPI Input & RS-485 I/O Pin-Out

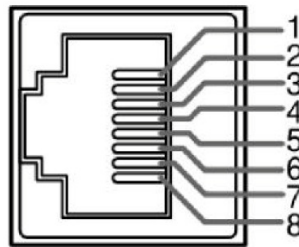

Table 2-3: RS-485 I/O Connections

Pin	RS-485 Terminal Name
1, 2	GND
3	Tx- (pair A)
4	Rx+ (pair B)
5	Rx- (pair B)
6	Tx+ (pair A)
7, 8	NC

Using the Quick Menu and the OSD Menus

In the following descriptions, refer to Figure 2-5 for the location of each control button.

Figure 2-5: Screen Control Buttons

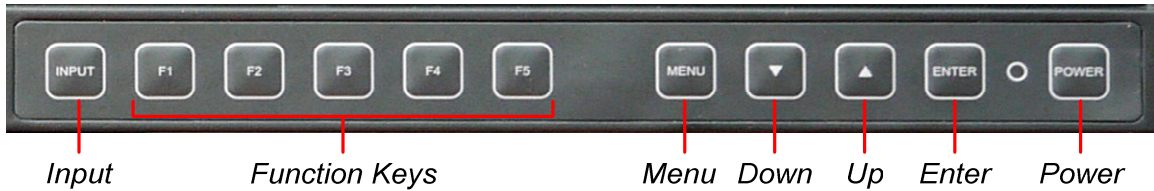

Quick Menu

The Quick Menu provides quick access to a few commonly used features, as listed in Table 2-4. The Quick Menu appears as shown in Figure 2-6.

Figure 2-6: Quick Menu - Volume Setting

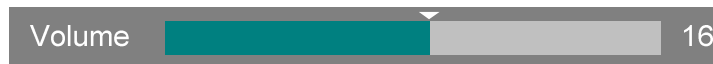

The following is a description of how to use the Quick Menu:

1. Press the **Enter** button to display the Quick Menu and the first item that can be adjusted.
2. Use the **Up** and **Down** buttons to change the value for the item displayed.
3. Press the **Enter** button again to display the next adjustable item.
4. The Quick Menu will time out with no button presses. Alternatively, you may press the **Enter** button repeatedly when finished until the menu disappears.

Table 2-4: Quick Menu

Parameters	Default Value	Domain Range
VOLUME	16	0 - 31
BRIGHTNESS	50	0 - 100
CONTRAST	50	0 - 100
CHROMA	50	0 - 100

OSD Menus

The OSD Menus allow you to adjust a wide variety of control parameters for the monitor. Refer to Table 2-5 through Table 2-17 for typical values and domain ranges. The following is a description of how to use the OSD Menu:

1. Press the **Menu** button to display the Main Menu.
2. Use the **Up** and **Down** buttons to navigate through the submenus.
3. Press the **Enter** button to enter the parameter selections in the chosen submenu.
4. Use the **Up** or **Down** buttons to cycle through the submenu selections.
5. When the desired option is highlighted, press the **Enter** button to select it.
6. Use the **Up** or **Down** buttons to adjust the parameter value up or down, make a selection, or turn a function on or off.
7. Press the **Enter** button to accept your parameter change -or- press the **Menu** button to cancel your change.
8. Press the **Menu** button to back out of any submenu, and finally to remove the OSD Menus from the screen.

OSD Menu

The following tables describe the information and settings available in the OSD Menu system. Use the instructions in the previous section to navigate the menus.

Table 2-5: Status Menu Structure

Status			
Parameters	Default Value	Domain Range	Description
INPUT	SDI-1	SDI-2, SDI-2, LINE 1 (CVBS), LINE 2 (CVBS), LINE 2 (Y/C), LINE 2 (YPBPR), HDMI	Display only, for the value of the parameter.
FORMAT	NO SIGNAL		
COLOR TEMP	D65	D32, D93, D65, D56, D50	
SCAN MODE	NORMAL	NORMAL, OVER, UNDER	
FAST MODE	ON	OFF, ON	
MODEL	RMT-173T-3G		
SERIAL NUMBER	-		
IP ADDRESS	192.168.1.86		
COLOR VERSION	2015-9-16-1		

Table 2-6: Input Menu Structure

Input			
Parameters	Default Value	Domain Range	Description
SDI 1	ON	OFF, ON	Enables or disables the input choices available in the Input Select Menu
SDI 2	ON	OFF, ON	
LINE 1	ON	OFF, ON	
LINE 2	CVBS	OFF, CVBS, LINE 2 (Y/C), LINE 2 (YPBPR)	
HDMI	ON	OFF, ON	
NTSC SETUP	7.5	0: Japan 7.5: North America	Select the NTSC signal region.
NTSC PHASE	0	-50 to 50	
FOCUS ASSIST	STANDARD	OFF STANDARD COLOR	OFF: Normal Video STANDARD: An image with sharpened edges is displayed. COLOR: An image with the color selected in FOCUS COLOR substituted for the intensified areas.
FOCUS LEVEL	49	0 to 100	Select the amount of edge sharpening in FOCUS ASSIST.
FOCUS COLOR	GREEN	RED BLUE GREEN	When FOCUS ASSIST: COLOR is selected, this selects which color will substitute.
LUMA ZONE CHECK	ON	OFF, ON	OFF: Normal Video ON: Compares the signal luminance with the LUMA ZONE LEVEL setting and fills the higher luminance areas with a zebra pattern.
LUMA ZONE LEVEL	49	0 to 100	Set the luminance comparison level for the LUMA ZONE CHECK.

The **Focus Assist** feature is designed to help with camera focusing. The **Luma Zone Check** feature can help when setting the camera exposure.

Table 2-7: Marker Menu Structure

Marker			
Parameters	Default Value	Domain Range	Description
MARKER ENABLE	OFF	OFF, ON	Turn all markers on or off.
AREA MARKER	15:9	If 16:9 aspect ratio: OFF (close area marker), 4:3, 13:9, 14:9, 15:9, 1.85:1, 2.35:1 If 4:3 aspect ratio: OFF (close area marker), 16:9	Set area marker size according to the aspect ratio.
CENTER MARKER	OFF	OFF, ON	Turn center marker display on or off.
SAFETY MARKER	OFF	OFF, 80%, 85%, 88%, 90%, 93%, 95%	Set safety marker size according to the aspect ratio and scan mode.
MARKER LEVEL	1	1: 50%, 2: 75%, 3: 100%	Set the luminance of all of the markers.
MARKER MAT	OFF	OFF, HALF (<i>Background 50%</i>) BLACK	Set the transparency of the area marker mat.
CROSSHATCH	ON	OFF, ON	

Figure 2-7: Marker Mat Effect



Marker Mat = OFF

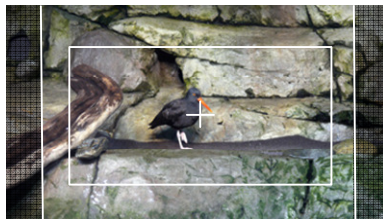

Marker Mat = HALF

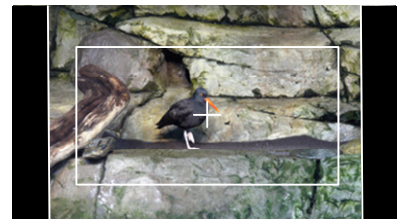

Marker Mat = BLACK

Table 2-8: Audio Menu Structure

Audio			
Parameters	Default Value	Domain Range	Description
AUDIO SOURCE	EXT	EXT: Analog Inputs EBD: SDI & HDMI Inputs UNDEF: No audio	Select the audio source among the available signals.
SPEAKER L	AUD 1L	OFF For an AUD Source: AUD 1L, AUD 1R, AUD 2L, AUD 2R	Select the input channel for the left speaker, headphone, or analog audio out.
SPEAKER R	AUD 1R	For an SDI EBD Source: CH1 to CH16 For an HDMI EBD Source: CH1, CH2	Select the input channel for the right speaker, headphone, or analog audio out.
AUDIO METER	OFF	ON or OFF	Set whether to display the audio meters.
METER SELECT	CH1-2	CH1-2, G1, G2, G3, G4, G1+G2, G1+G3, G1+G4, G2+G3, G2+G4, G3+G4, G1-G4	Select channels or SDI groups to display on the meters.
METER DIRECTION	HORIZONTAL	VERTICAL, HORIZONTAL	Select vertical or horizontal meters.
METER POSITION	TOP	If METER DIRECTION is VERTICAL: BOTTOM LEFT, BOTTOM RIGHT, TOP RIGHT, TOP LEFT If METER DIRECTION is HORIZONTAL: BOTTOM, TOP	For vertical meters, select bottom left, bottom right, top right, or top left position. For horizontal meters, select bottom or top position.
METER DIS MODE	MODE1	MODE1: meter only MODE2: meter & channel numbers MODE3: meter, channel numbers, and dB value	Select the appearance of the meters.
REF LEVEL	-20DB	-18DB, -20DB	Set the meter reference level (green to yellow transition).
OVER LEVEL	-10DB	-2DB, -4DB, -6DB, -8DB, -10DB	Set the meter over level (yellow to red transition)

Table 2-9: Display Menu Structure

Display			
Parameters	Default Value	Domain Range	Description
STATUS DISPLAY	AUTO	OFF, ON, AUTO	Turn status display off, on, or automatic. If automatic, it will display for 15 seconds after each change.
AFD DISPLAY	OFF	ON, OFF	Turn AFD display on only when status display is set to On or Auto, or else Off.
WFM FORM TYPE	OFF	OFF WAVEFORM VECT75 VECT100	Set the type of waveform / vector display.
LINE WAVE	OFF	ON, OFF	Set whether to display the line wave.
LINE WAVE NUMBER	---	Refer to Table 2-9.	Set the position of the waveform display.
WAVEFORM OVER LIMIT	50	50 to 100	Set the over limit of the waveform.
WAVEFORM UNDER LIMIT	5	0 to 50	Set the under limit of the waveform.
WFM TRANS	TRANS3	TRANS1 TRANS2 TRANS3 OPAQUE	Set the degree of transparency of the waveform display.
WAVEFORM POSITION	BOT RIGHT	BOTTOM RIGHT BOTTOM LEFT TOP LEFT TOP RIGHT	Set the displayed position for the waveform display.
TIME CODE	OFF	OFF, D-VITC, LTC, VITC	Select the mode for the time code display or disable it.

Table 2-10: Line Wave Number vs. Input Signal

Input Signal	Default Value	Domain Range
576i50	310	23 - 623
480i60	261	22 - 524
720p	386	26 - 745
1080i50	560	21 - 1123
1080i60/59.94		
1080sf23/23.97		
1035i60	557	41 - 1120
1080p	561	42 - 1121

Table 2-11: Closed Caption Menu Structure

Closed Caption			
Parameters	Default Value	Domain Range	Description
SDI CC LOG	OFF	OFF, ON	Set whether to display SDI closed caption information.
CLOSED CAPTION	ON	OFF, ON	Set whether to display CVBS closed caption information.
SDI CC TYPE		AUTO1 AUTO2 608(708) 608(ANC) 608(VB1)	Set type of SDI caption to display.
608 CHANNEL SEL	CC2	CC1 CC2 CC3 CC4 TEXT1 TEXT2 TEXT3 TEXT4	Set type of CVBS caption to display.

Table 2-12: Config Menu Structure

Config			
Parameters	Default Value	Domain Range	Description
FAST MODE	OFF	ON or OFF	Enable or disable fast mode.
FILM MODE DETECT	OFF	ON or OFF	Enable or disable film mode detection.
SUB IN TYPE	OFF	PIP PBP OFF	Select Picture by Picture (PbP) or Picture in Picture (PiP).
SUB IN SELECT	SDI2	SDI2 LINE1 (CVBS) LINE2 (CVBS) LINE 2 (Y/C) LINE2 (YPBPR) HDMI	Select the source for the PbP or PiP.
PIP SIZE	LARGE	LARGE, SMALL	Select the size of the PiP.
PIP POSITION	BOT RIGHT	BOTTOM RIGHT TOP RIGHT TOP LEFT BOTTOM LEFT	Select the position of the PiP.
BACK LIGHT	15	0* to 30	Set backlight timeout.
AUTO STANDBY	OFF	ON or OFF	Enable or disable auto standby mode.
APERTURE	0	0 to 24	Set picture sharpness.
LOCK NUMBER	-		Set lock number.
LANGUAGE	ENGLISH	ENGLISH, CHINESE	Set the menu language.
H FLIP	OFF	OFF, ON	Set to flip the picture horizontally or not.
UNIFORMITY	ON	OFF, ON	Adjust uniformity.

* **Note:** Use caution when setting the Back light to a very low number. Setting the Back Light to 0 or a low number may make it impossible to see the menus to correct the situation.

Table 2-13: Color Temp Menu Structure

Color Temp			
Parameters	Default Value	Domain Range	Description
COLOR TEMP	D65	D32, D50, D56, D65, D93, USER1, USER2	Set the color temperature.
RED GAIN	128	0 to 256	Set the gain for each color.
GREEN GAIN			
BLUE GAIN			
RED BIAS	0	-127 to +127	Set the offset for each color.
GREEN BIAS			
BLUE BIAS			
COPY FROM	D93	D32, D50, D56, D65, D93	Copies this set of color parameters to USER.
RESET	Resets Gain and Offset to Factory Default		
COLOR SPACE	AUTO	USER, NATIVE, EBU, SMPTE-C, ITU-709, AUTO	Select the color matrix.

Table 2-14: Function Key Menu Structure

Function Key			
Parameters	Default Value	Domain Range	Description
F1	SCAN	SCAN	Set up the F1 Function key action.
F2	NATIVE	NATIVE	Set up the F2 Function key action.
F3	ASPECT	ASPECT	Set up the F3 Function key action.
F4	WIN SELECT	WIN SELECT	Set up the F4 Function key action.
F5	PBP	PBP	Set up the F5 Function key action.

Table 2-15: GPI Menu Structure

GPI			
Parameters	Default Value	Domain Range	Description
GPI1	TALLY GREEN	AREA MARKER CENTER MARKER SAFETY MARKER ASPECT NATIVE OVER SCAN UNDER SCAN BLUE ONLY MONO H DELAY V DELAY H/V DELAY SDI1 SDI2 LINE1 LINE2 HDMI TALLY GREEN TALLY RED UNDEF (none)	Set up the action of GPI1.
GPI2	TALLY RED		Set up the action of GPI2.
GPI3	NATIVE		Set up the action of GPI3.
GPI4	UNDER SCAN		Set up the action of GPI4.
GPI5	MONO		Set up the action of GPI5.
GPI6	H/V DELAY		Set up the action of GPI6.

Table 2-16: IMD Menu Structure

IMD Menu			
Parameters	Default Value	Domain Range	Description
IMD DISPLAY	ON	ON or OFF	Set whether to enable the IMD.
IMD COLOR	RED	RED, GREEN, YELLOW, WHITE	Set the color of the IMD characters.
IMD CHARACTER	RMT-173-3G	(Up to 16 characters of text for static LOCAL display)	Set the IMD message.*
IMD PROTOCOL	LOCAL	LOCAL TSL3.1, TSL4.0, TSL5.0 IMAGE VIDEO (1510 protocol) NETWORK	Select an IMD protocol.
IMD ID	0	0 to 255 (unit ID number for Dynamic IMD/Tally)	Set the ID number for the IMD.
IMD NAME	-	(Up to 16 characters of text for the IMD Name)	Set the ID Name for dynamic IMD/Tally.*
BAUD RATE	115200	2400, 4800, 9600, 19200, 38400, 57600, 115200	Set the BAUD rate for RS-485 communication.
LED TALLY	ON	ON or OFF	Enable / disable the Tally light.
OSD TALLY MODE	RG	OFF, RG: Red/Green, GR: Green only, RGY: Red/Green/Yellow	Select the OSD tally mode.
IMD TALLY MODE	T1	T1, T2, T1T2, T2T1, T1-, T2-, T1T2-, T2T1-	Select the IMD tally mode for Image Video.
TALLY SOURCE	STANDARD	STANDARD (rear Tally connector), IMAGE VIDEO, TSL	Select the tally source.

* **To enter the characters** for the IMD CHARACTER or IMD NAME SETTINGS, navigate to the setting and press Enter. Press Up or Down repeatedly to locate the first character and press Enter to move to the next character. Press Up or Down again repeatedly to locate the second character and press Enter. Repeat this process until all of the characters (up to 16) have been entered. Then press Menu to exit.

Table 2-17: Key Inhibit Menu Structure

Key Inhibit			
Parameters	Default Value	Domain Range	Description
KEY INHIBIT	OFF	OFF, ON	

CHAPTER 3: Technical Info

Table 3-1: Specifications

Specification	Values/Domains
Power requirements	100 V to 240 VAC \pm 10%, 50/60Hz
Power consumption	60 Watts
RMT-173-3G-TT with tabletop stand: inches H x W x D (mm)	12.5" H x 16.5" W x 6.3" D 305 mm H x 420 mm W x 160 mm D
RMT-173-3G-RM 6RU: inches H x W x D (mm)	10.5" H (6U) x 19" W x 2.7" D 267 mm H x 483 mm W x 70 mm D
Weight	13 lbs. (5.9 kg)
Space Required	6RU in a standard 19" rack (RMT-173-3G-RM)
Supplied Accessories	Power Adapter, AC Power Cord
Display Type	IPS-LCD with LED Backlight
Number of Displays	1
Screen Size	17.3" diagonal per screen
Screen Resolution	1920(H) x 1080(V)
Aspect ratio	16:9, 4:3
Display Area (mm)	372.9(H) x 209.7(V)
Viewing Angle	178°(H) x 178° (V)
Color Depth	16.7M colors
Contrast Ratio	700:1
Brightness	300 cd/m ² , typical
Backlight	White LED
Response Time	25 ms, typical
Video Inputs	CVBS: PAL/NTSC
	Component Video: YPrPb or Y/C
	SD-SDI: SMPTE 259M, ITU-R BT.656
	HD-SDI: SMPTE 292M/274M/296M
	3G-SDI: SMPTE 425-Level A
	DVI/HDMI: 1.3a
Video Input Impedance	SDI and CVBS: 75 Ω
Audio Inputs	2 Stereo Pairs; Analog on RCA
Audio Input Impedance	20k Ω
Audio Outputs	1 Selected Pair; 1/8" Headphone jack and Analog on RCA

Speakers	5W x 2 (Stereo)
Dynamic Tally/IMD	RS-485; TSL/ImageVideo on RJ-45
Network Setup/Control	10/100M Ethernet; Web Server on RJ-45
GPI Inputs	6 Contact Closures

Figure 3-1: RMT-173-3G Series Block Diagram

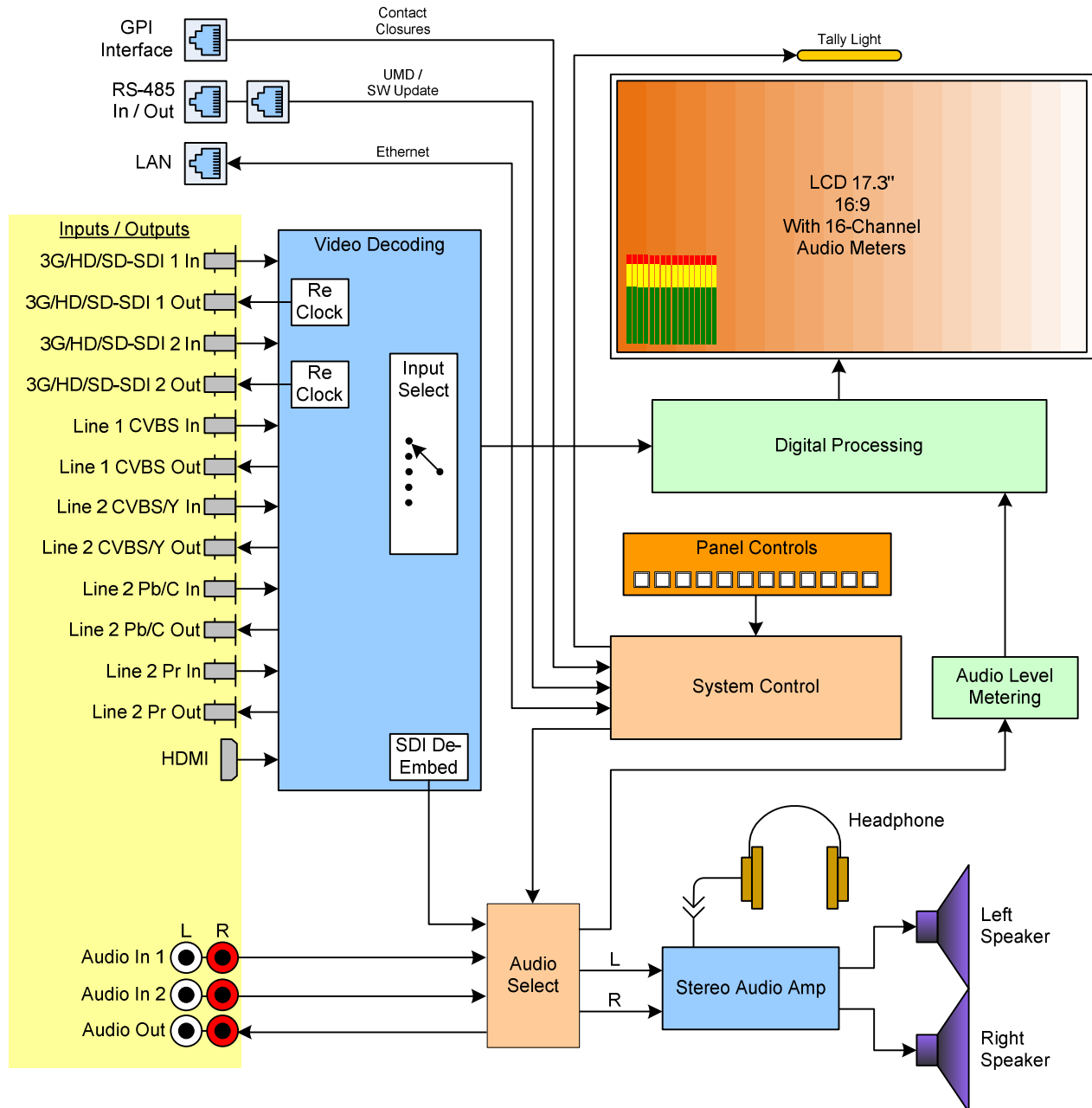

Supported Video Formats

The RMT-173-3G Series monitors will display the video formats listed in Table 3-2.

Table 3-2: Video Formats

Format	SDI	Video, Y/C	YPbPr	HDMI	DVI-D
PAL		X			
NTSC		X			
480i60/59.94	X		X	X	
576i50	X		X	X	
480p60/59.94			X	X	
576p50			X	X	
720p24/23.97	X		X	X	
720p25	X		X	X	
720p30/29.97	X		X	X	
720p50	X		X	X	
720p60/59.94	X		X	X	
1080sf24.23.97	X		X	X	
1035i60/59.94	X		X	X	
1080i50	X		X	X	
1080i60/59.94	X		X	X	
1080p24/23.97	X		X	X	
1080p25	X		X	X	
1080p30/29.97	X		X	X	
1080p50	X		X	X	
1080p60/59.94	X		X	X	
VGA (640X480)					X
SVGA (800X600)					X
XGA (1024X768)					X
SXGA (1280X1024)					X
WXGA (1360X768)					X
WXGA+ (1440X900)					X
WXGA+ (1400X1050)					X
UXGA (1600X1200)					X
UXGA+ (1680X1050)					X
WUXGA (1920X1080)					X
WUXGA (1920X1200)					X

CHAPTER 4: Using Network Control

The RMT-173-3G Series Web GUI allows you to customize the monitor configuration to perfectly suit your needs. The following setup steps are not necessary if you intend to use the RMT-173-3G in its default configuration or if you only make configuration changes using the OSD menus. However, the RMT-173-3G Web GUI network control is ideal for configuring difficult to access monitors.

Web Browser / Control Device

Any web browser application running on any networked device such as desktop or laptop computer, tablet, or smart phone can be used with the RMT-173-3G Web GUI.

If a tablet without a physical network connector is to be used, it needs to be linked to a copper LAN through a Wi-Fi adaptor.

Phones are not recommended due to their smaller screen size, which would require more scrolling.

The Chrome[®] web browser is recommended for speed and compatibility.

First Time- IP Assignments

The RMT-173-3G operates with a static (fixed) IPv4 address. The address will be **192.168.1.86** when received from the factory or when reset at the front panel. This is shown in Figure 4-2. The IP address will need to be changed to some other address to be compatible with the customer's network address assignments. Go to [System setup](#), immediately after this host setup is done, to change the unit's address.

The surest way to do this, free of possible network conflicts, is to establish a direct peer-to-peer connection between the setup computer and the RMT-173-3G. A 10/100/1000 MHz Ethernet switch may be used in between, but is not required.

Figure 4-1 shows an example of suitable address settings for the host computer in a Windows 7 control panel.

Figure 4–1: Host IP Settings

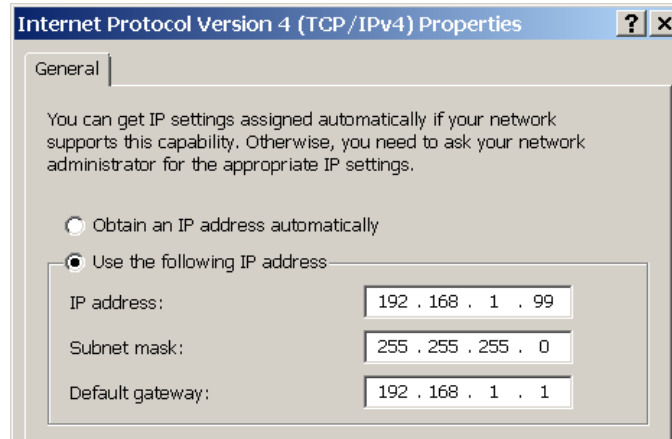

After making an IP address change such as this, close the control panel and reboot the host computer to be sure the change takes effect.

Make the final address, mask and gateway changes in the RMT-173-3G [System setup](#) page.

Status Page

The full network control browser window is shown in Figure 4-2. Enter the IP Address of the monitor into the address bar on your browser and press the Enter key to access the web server.

The various menu pages of settings are quickly selected by clicking one of the 14 selector buttons arranged vertically at the left.

Most of the settings shown on the pages in the Web GUI apply to the system in general, regardless of which input source is selected. However, if there is an **(S)** icon following a parameter name, it indicates that this parameter is individually saved according to the input source selection on the bar at the top of the page. These special settings will be saved according to the **SDI 1**, **SDI 2**, **Line 1**, **Line 2**, **HDMI**, or **Apply to All** selection made in the Input Source Selection Bar.

Figure 4-2: Status Page

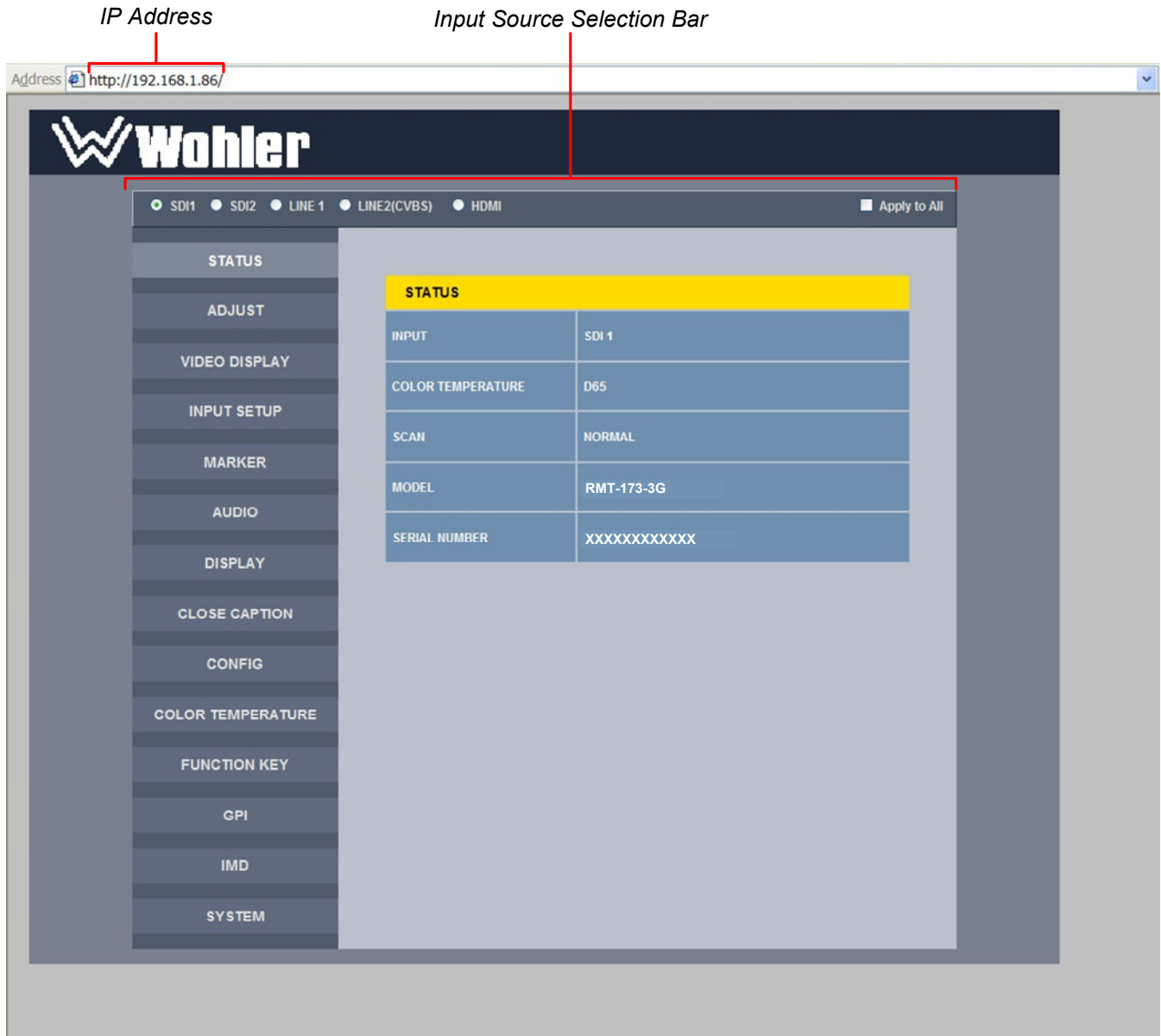

Adjust Page

The **(S)** icon following some of the items in this menu indicates that this parameter is individually saved according to the choice made in the Input Source Selection Bar, as shown in Figure 4-2.

Certain settings include a **SET** button. To change these parameters, first make the change and then click the **SET** button to put the change into effect.

Figure 4-3: Adjust Page

ADJUST	
CONTRAST (S)	75 <input type="button" value="SET"/>
BRIGHT (S)	59 <input type="button" value="SET"/>
CHROMA (S)	60 <input type="button" value="SET"/>
MONO	<input checked="" type="radio"/> NORMAL <input type="radio"/> MONO
MUTE	<input checked="" type="radio"/> Current Audio Level <input type="radio"/> MUTE
FREEZE	<input checked="" type="radio"/> OFF <input type="radio"/> ON
WIN SOURCE	<input checked="" type="radio"/> MAIN <input type="radio"/> SUB
VOLUME (S)	0 <input type="button" value="SET"/>

Video Display Page

Figure 4-4: Video Display Page

VIDEO DISPLAY	
SCAN	NORMAL <input type="button" value="SET"/>
NATIVE	<input checked="" type="radio"/> OFF <input type="radio"/> ON

Input Setup Page

This menu is not used to select input sources, but instead is used to determine which input sources appear as choices in the **Input** button menu on screen. If an input is not connected, it makes sense to not have it appear in the **Input** button menu.

Figure 4-5: Input Setup Page

INPUT SETUP	
SDI 1	<input type="radio"/> OFF <input checked="" type="radio"/> ON
SDI 2	<input type="radio"/> OFF <input checked="" type="radio"/> ON
LINE 1	<input type="radio"/> OFF <input checked="" type="radio"/> ON
LINE 2	LINE2(CVBS) <input type="button" value="SET"/>
HDMI	<input type="radio"/> OFF <input checked="" type="radio"/> ON
NTSC SETUP	<input type="radio"/> 0 <input checked="" type="radio"/> 7.5
NTSC PHASE	0 <input type="button" value="SET"/>
FOCUS ASSIST	OFF <input type="button" value="SET"/>
FOCUS ASSIST LEVEL	50 <input type="button" value="SET"/>
FOCUS ASSIST COLOR	RED <input type="button" value="SET"/>
LUMA ZONE CHECK	<input checked="" type="radio"/> OFF <input type="radio"/> ON
LUMA ZONE LEVEL	50 <input type="button" value="SET"/>

Marker Page

The **MARKER OFF/ON** setting enables or disables the visibility of all markers on the screen. The settings of each marker are retained as the last change made from either the OSD Menu or this Network Control Page.

Figure 4–6: Marker Page

MARKER	
MARKER	<input checked="" type="radio"/> OFF <input type="radio"/> ON
AREA MARKER	2.35:1 <input type="button" value="SET"/>
SD ASPECT	<input type="radio"/> OFF <input checked="" type="radio"/> 16:9
CENTER MARKER	<input type="radio"/> OFF <input checked="" type="radio"/> ON
SAFETY MARKER	90% <input type="button" value="SET"/>
MARKER LEVEL	1 <input type="button" value="SET"/>
MARKER MAT	HALF <input type="button" value="SET"/>
CROSS HATCH	<input checked="" type="radio"/> OFF <input type="radio"/> ON

Audio Page

First select the **AUDIO SOURCE**. Then select **SPEAK(er) OUT** selections for **LEFT** and **RIGHT** channels. These selections also apply to the AUDIO OUT and HEADPHONE outputs.

METER SELECT controls which and how many channels are metered, independently of the SPEAK(er) OUT selections.

The **(S)** icon following some of the items in this menu indicates that this parameter is individually saved according to the choice made in the Input Source Selection Bar, as shown in Figure 4-2.

Certain settings include a **SET** button. To change these parameters, first make the change and then click the **SET** button to put the change into effect.

Figure 4–7: Audio Page

AUDIO	
AUDIO SOURCE (S)	EMBEDDED <input type="button" value="SET"/>
SPEAK OUT LEFT (S)	EBD CH1 <input type="button" value="SET"/>
SPEAK OUT RIGHT (S)	EBD CH2 <input type="button" value="SET"/>
AUDIO METER	<input checked="" type="radio"/> OFF <input type="radio"/> ON
METER SELECT	G1-4 <input type="button" value="SET"/>
REF LEVEL	<input checked="" type="radio"/> -20DB <input type="radio"/> -18DB
OVER LEVEL	-10DB <input type="button" value="SET"/>
METER DIRECTION	<input checked="" type="radio"/> VERTICAL <input type="radio"/> HORIZONTAL
METER POSITION	BOT LEFT <input type="button" value="SET"/>
METER DIS MODE	MODE1 <input type="button" value="SET"/>

Display Page

Figure 4–8: Display Page

DISPLAY	
STATUS DISPLAY	AUTO <input type="button" value="v"/> <input type="button" value="SET"/>
AFD DISPLAY	<input checked="" type="radio"/> OFF <input type="radio"/> ON
WFM TRANS	OPAQUE <input type="button" value="v"/> <input type="button" value="SET"/>
WAVE FORM MODE	WFMFORM+VECT100 <input type="button" value="v"/> <input type="button" value="SET"/>
WFM POSITION	<input type="radio"/> LEFT <input checked="" type="radio"/> RIGHT
WAVE OVER LIMIT	100 <input type="button" value="SET"/>
WAVE UNDER LIMIT	0 <input type="button" value="SET"/>
TIME CODE	OFF <input type="button" value="v"/> <input type="button" value="SET"/>
LINE WAVE	<input checked="" type="radio"/> OFF <input type="radio"/> ON

Close Caption Page

Figure 4–9: Close Caption Page

CLOSE CAPTION	
CLOSE CAPTION	<input checked="" type="radio"/> OFF <input type="radio"/> ON
SDI CC TYPE	608(VBI) <input type="button" value="v"/> <input type="button" value="SET"/>
608	CC1 <input type="button" value="v"/> <input type="button" value="SET"/>
SDI CC LOG	<input checked="" type="radio"/> OFF <input type="radio"/> ON

Config Page

The **(S)** icon following some of the items in this menu indicates that this parameter is individually saved according to the choice made in the Input Source Selection Bar, as shown in Figure 4-2.

Certain settings include a **SET** button. To change these parameters, first make the change and then click the **SET** button to put the change into effect.

Figure 4-10: Config Page

CONFIG	
FAST MODE (S)	<input checked="" type="radio"/> OFF <input type="radio"/> ON
FILM MODE DET (S)	<input checked="" type="radio"/> OFF <input type="radio"/> ON
SUB IN TYPE	OFF <input type="button" value="v"/> <input type="button" value="SET"/>
SUB IN SELECT	SDI 2 <input type="button" value="v"/> <input type="button" value="SET"/>
PIP SIZE	<input type="radio"/> SMALL <input checked="" type="radio"/> LARGE
PIP POSITION	TOP RIGHT <input type="button" value="v"/> <input type="button" value="SET"/>
BACKLIGHT	15 <input type="button" value="SET"/>
AUTO STANDBY	<input checked="" type="radio"/> OFF <input type="radio"/> ON
APPERTURE (S)	0 <input type="button" value="SET"/>
LANGUAGE	<input checked="" type="radio"/> ENGLISH <input type="radio"/> 中文
H FLIP	<input checked="" type="radio"/> OFF <input type="radio"/> H FLIP
UNIFORMITY	<input type="radio"/> OFF <input checked="" type="radio"/> ON

Color Temperature Page

Figure 4–11: Color Temperature Page

COLOR TEMPERATURE	
COLOR TEMPERATURE	D65 <input type="button" value="SET"/>
COLOR SPACE	AUTO <input type="button" value="SET"/>

Function Key Page

The effect that each of the five function keys has can be set in this page. The available functions are:

- | | | |
|------------|--------------|-----------------|
| SCAN | NATIVE | ASPECT |
| BLUE ONLY | MONO | MARKER |
| H/V DELAY | AUDIO METER | FAST MODE |
| TC | IMD | MUTE |
| PBP | CC | FREEZE |
| WIN SELECT | FOCUS ASSIST | LUMA ZONE CHECK |
| H FLIP | UNDEF (none) | |

Figure 4–12: Function Key Page

FUNCTION KEY	
F1	LUMA ZONE CHECK <input type="button" value="SET"/>
F2	AUDIO METER <input type="button" value="SET"/>
F3	TC <input type="button" value="SET"/>
F4	IMD <input type="button" value="SET"/>
F5	MARKER <input type="button" value="SET"/>

IMD Page

There are two ways to enter static IMD character strings, via the network with this page, or with the OSD IMD Menu. Both are retained in the monitor's memory, and **IMD PROTOCOL** settings of **LOCAL** vs. **NETWORK** decides which one is displayed.

Figure 4-13: IMD Page

IMD	
IMD DISPLAY	<input checked="" type="radio"/> OFF <input type="radio"/> ON
IMD COLOR	RED <input type="button" value="SET"/>
IMD CHARACTER	<input type="text"/> <input type="button" value="SET"/>
IMD PROTOCOL	LOCAL <input type="button" value="SET"/>
IMD ID	0 <input type="button" value="SET"/>
IMD NAME	XXXXXXXXXXXXXXXXXXXX <input type="button" value="SET"/>
BAUD RATE	115200 <input type="button" value="SET"/>
LED TALLY	<input type="radio"/> OFF <input checked="" type="radio"/> ON
OSD TALLY MODE	RG <input type="button" value="SET"/>
IMD TALLY MODE	T1 <input type="button" value="SET"/>
TALLY SOURCE	STANDARD <input type="button" value="SET"/>

GPI Page

The effect that the six GPI contact closure inputs have can be specified in this menu page. The available choices are:

- | | | |
|-------------|---------------|---------------|
| AREA MARKER | CENTER MARKER | SAFETY MARKER |
| ASPECT | NATIVE | OVER SCAN |
| UNDER SCAN | BLUE ONLY | MONO |
| H DELAY | V DELAY | H/V DELAY |
| SDI1 | SDI2 | LINE1 |
| LINE2 | HDMI | TALLY GREEN |
| TALLY RED | UNDEF (none) | |

Figure 4–14: GPI Page

GPI	
GPI1	TALLY GREEN <input type="button" value="SET"/>
GPI2	TALLY RED <input type="button" value="SET"/>
GPI3	NATIVE <input type="button" value="SET"/>
GPI4	BLUE ONLY <input type="button" value="SET"/>
GPI5	MONO <input type="button" value="SET"/>
GPI6	H/V DELAY <input type="button" value="SET"/>

System Page

Set a unique **IP ADDRESS** for each RMT-173-3G monitor to be used in a local area network (LAN).

The **MASK** is usually set as shown, but can be altered to suit your IT configuration and administration needs.

The first three **GATEWAY** number blocks usually match the first three number blocks of the IP ADDRESS, and the last number is usually 1.

The **LOCK NUMBER** is only needed in certain software installation situations. Do not change it unless instructed by Wohler Customer Service.

Version numbers are additional information that may be useful when consulting with Wohler Customer Service.

Figure 4–15: System Page

SYSTEM	
ADDRESS	192.168.1.86 SET
MASK	255.255.255.0 SET
GATEWAY	192.168.1.1 SET
LOCK NUMBER	<input type="text"/> SET
MPU Version	2327
FPGA Version	1117
NCU Version	1031