

iAM MIX-16



Multi-Channel Audio Monitoring & Metering of IP and Baseband Signals



Intuitive monitoring and mixing of audio from multiple sources, with browser-based user interface and API's



The iAM Command & Control Interface

Wohler Technologies has been in business for over 30 years. We invented in-rack monitoring and we are now RE-INVENTING this broadcast technology for the modern media enterprise to handle IP MONITORING.

Flexible. Adaptable. Future Proof.

Specifically designed for fast-paced OB, studio and live-to-air production environments, iAM-MIX provides intuitive audio signal monitoring with instant access to signals or to user-definable presets of any individual signal source or a mix of sources for monitoring and mixing. **Signal options include the latest IP formats: SMPTE 2110, SMPTE 2022, Ravenna™/AES67 and Dante™**

Choose from either 8 or 16 level controls, both with an independent master level control and instant mute capability and push-for-solo capability. Individual OLED display indicators show status, presence metering and channel name – which can be manually edited or automatically read from a network connected router.

Multiple units on the same network can be controlled via a browser-based user interface that supports fast configuration with role-based authentication to protect critical setups. In short, iAM-MIX is the perfect solution for any application that requires a simple, compact solution for monitoring a range of audio signals.

Features/Benefits:

- Fast selection and summing of up to 8 audio channels, allowing quick muting and hold-for-solo
- Master volume control that also provides a master mute/unmute
- Channel names can be displayed for each input or pulled from a router
- Built-in speakers, headphone jack, USB and Ethernet ports
- A range of included and optional connectors and signal processing options, including SFP slots for future I/O and Ethernet inputs for IP-based I/O
- Store and retrieve up to 64 presets (8 accessible on front panel)
- Software upgradeable via USB or network, upgrade multiple units at once
- APIs for remote control

Model	Part ID		Description
iAM-Mix8	8114-0090	Base Unit	1RU Base unit, includes Analog as standard
iAM-Mix16	8114-0140	Base Unit	1RU Base unit, includes Analog as standard
SFP-2110 w/Ember+	829086	I/O Option	Receiver; Multi-Mode 850 NM, LC Connectors
SFP-2110 w/NMOS	829086-1	I/O Option	Receiver; Multi-Mode 850 NM, LC Connectors
SFP-2022	829088	I/O Option	Receiver; LC Connectors
SFP-2110 w/Ember+ +2022-6	829087	I/O Option	Either-Or; Multi-Mode 850 NM, LC Connectors
SFP-2110 w/NMOS +2022-6	829087-1	I/O Option	Either-Or; Multi-Mode 850 NM, LC Connectors
SFP-SDI	829089	I/O Option	3G/HD/SD-SDI single video receiver w/ active loopback, HD-BNC
SFP-SDI-Fiber	829084	I/O Option	3G/HD/SD-SDI or ASI single receiver w/ active loopback, HD-BNC
OPT-AES	829080	I/O Option	Enables decoding and monitoring of 4 x AES inputs, 1 AES Output
OPT-MADI	829092	I/O Option	Enables decoding and monitoring of 1 x MADI64 input via BNC
SFP-MM-MADI-FIBER	829081	I/O Option	MADI fiber transceiver, Multimode; LC Connectors
SFP-SM-MADI-FIBER	829082	I/O Option	MADI fiber transceiver, Single mode; LC Connectors
OPT-DANTE	829078	Processing Option	Enables decoding and monitoring of Dante™ input streams
OPT-RAVENNA 256	829079	Processing Option	Enables monitoring of up to 256 ch Ravenna™ / AES67 Input. NMOS support
OPT-RAVENNA 64	829173	Processing Option	Enables monitoring of up to 64 ch Ravenna™ / AES67 Input. NMOS support
OPT-OUTPUT-ROUTING	829159	Processing Option	Enables the flexibility to route input signals to various outputs.

iAM MIX-16



Multi-Channel Audio Monitoring & Metering of IP and Baseband Signals

Rear Panel

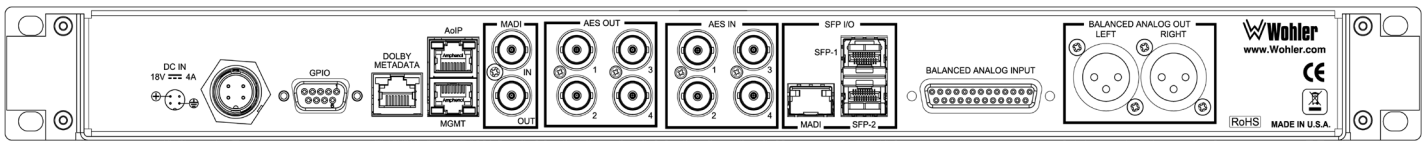

Block Diagram

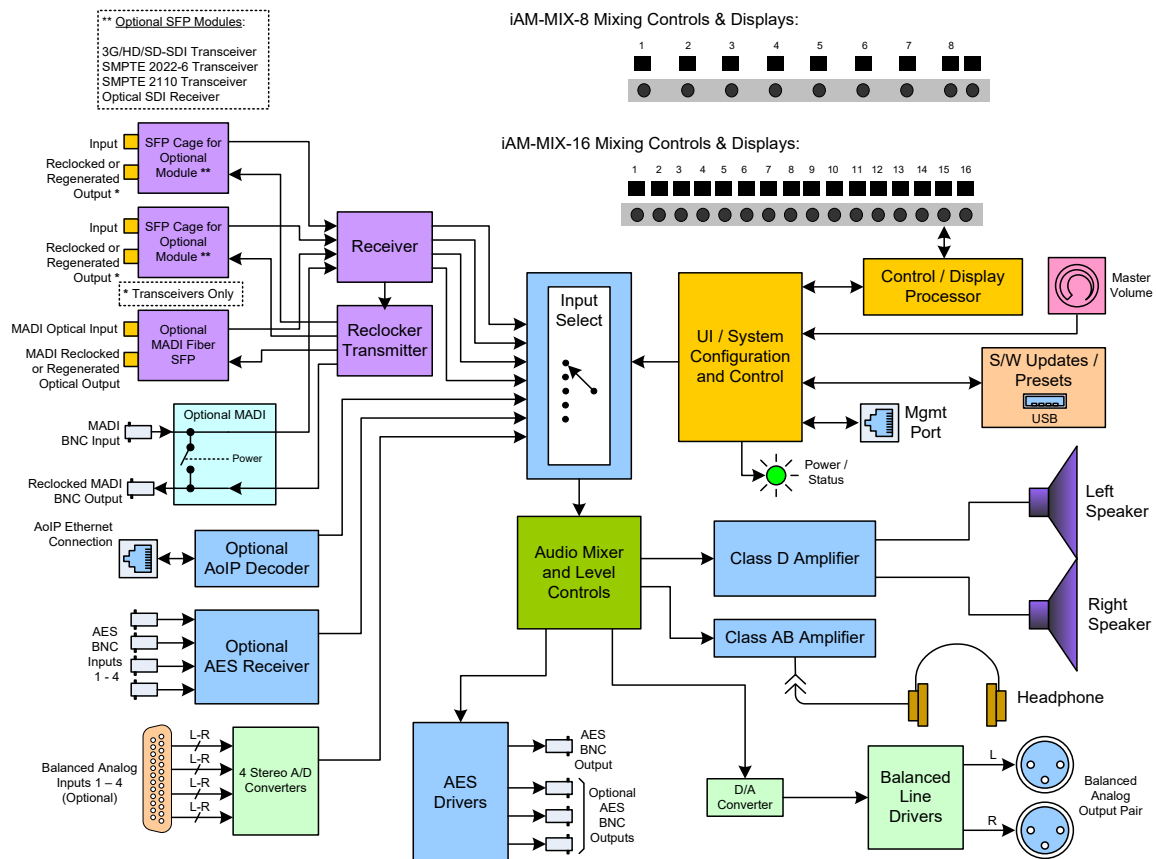

Specifications	iAM-MIX-8 / iAM-MIX-16
Height	1RU
Dimensions	19" x 1.75" x 6.5" (483 x 44 x 165 mm)
Shipping / Net Weight	8.5 lbs (3.9 kg) / 6.5 lbs (2.9 kg)
Power Supply	External: 18 VDC from 100 - 240 VAC ± 10%, 50/60 Hz, CE & UL approved
Power Consumption	40W typical
Display Type	Passive Matrix OLED x 9 / x 16
Audio Channel	8 Max / 16 Max
Frequency Response	150 Hz to 16 kHz (± 5 dB) acoustic, 40 Hz to 20 kHz (± 1dB) electrical
Peak Acoustic Output	90 dB SPL @ 2ft
Speaker Power Output	RMS Each Side: 4W Continuous /8W Peak
Upgrades	Via USB or GUI software & Ethernet; Upgrading multiple units available via web interface
Presets	iAM-Mix 8 * 8 / iAM-Mix-16 *16 programmable/nameable. Can be copied from unit to unit via USB or GUI software and Ethernet
Router Integrations	Units support Evertz, Grass Valley & Tallyman protocols for automated display of channel labels
Available APIs	Get Available Presets; Get Preset Information; Get Active Preset; Apply Preset; Set Mute/Unmute Channel; Set Solo Channel; Source Select

Specifications subject to change, errors and omissions excepted

All trademarks, product names and images are the property of their respective owners

Any rights not expressly granted herein are reserved. Rev: 06/09/2020

Wohler Technologies, Inc.

1280 San Luis Obispo. Hayward, CA, 94544, USA

+1 510 870 0810 | sales@wohler.com | www.wohler.com